



KEF R&D

BLADE
THE REFERENCE

CONTENTS

2	Introduction
2	Philosophy
2	BLADE
3	THE REFERENCE
3	High End 12th Generation Uni-Q with MAT
3	High Frequency Driver
4	Metamaterial Absorption Technology
4	Coupling MAT to the tweeter dome
4	Tangerine Waveguide Stiffening Ribs
5	HF Motor System
5	Tweeter Gap Damper
6	Midrange Driver
6	Ultra-Low Distortion MF Motor System
8	MF Surround and Spider
9	Flexible Decoupling Chassis
11	Crossover
12	Summary
13	Appendix (Blade)
13	Single Apparent Source
13	Force Cancelling
13	Cabinet Design
14	References
15	BLADE - Model Information, Specifications and Measurements
18	THE REFERENCE - Model Information, Specifications and Measurements



Introduction

The 12th Generation of KEF's signature driver technology – Uni-Q – is amongst one of the most significant in the company's history. Each iteration up to this point has sported considerable new technologies leading to improved clarity, detail, and performance.

The debut of this generation arose with R Series (2018), and the introduction of the Tweeter Gap Damper. This dealt with the annular channel resonances created by the gap formed between the midrange cone and the tweeter housing. This was soon followed by the world's first use of a metamaterial in a loudspeaker – KEF's patented Metamaterial Absorption Technology (MAT) – first developed for the LS50 Collection (LS50 Meta and LS50 Wireless II).

With KEF celebrating its 60th anniversary, and after the success experienced in implementing MAT in the LS50 Collection, it naturally followed to incorporate this technology into KEF's high-performance ranges. However, the engineering brief for the new Blade and The Reference upgrades went beyond simply incorporating MAT into their existing Uni-Qs. As is explained in this document, this project reassessed all technologies utilised by KEF to date and introduces fresh innovations, further cementing Blade and Reference as leading loudspeaker designs.

The result is the most advanced, highest performing speakers KEF has ever produced, where the approach has never been closer to Raymond Cooke's original design philosophy.

This paper will explain these new features. An appendix is provided to discuss Blade's Single Apparent Source technology in more depth. Interested readers can also refer to the Reference 2014 White Paper [1] for more information on Reference technologies (LF drivers, cabinet, and port design), which also serves as an excellent general discussion on loudspeaker design.

Philosophy

"Of all art, music is the most indefinable and the most expressive, the most insubstantial and the most immediate, the most transitory and the most imperishable. Transformed to a dance of electrons along a wire, its ghost lives on. When KEF returns music to its rightful habitation, your ears and

mind, they aim to do so in the most natural way they can... without drama, without exaggeration, without artifice."

Raymond Cooke OBE, KEF Founder

These words were penned shortly after KEF's founding in 1961. Cooke was an avid music lover and his mission from the outset was to enable a wide audience to derive the same pleasure from music as he did. He sought to deliver to his customers the immersive experience of a live performance through recordings.

Cooke realised that this could only be achieved through scientific understanding of sound and its reproduction. He concentrated his efforts on loudspeakers - the last and probably most difficult link in the chain, in that they must work in an unknown three-dimensional environment. Never afraid to employ the most capable engineers and provide them with the latest and most effective tools, Cooke established an engineering philosophy that still exists today.

KEF engineers continue to pursue this scientific endeavour, using tools and technology that were unavailable to Cooke in those early days. The listening experience is still the final arbiter in deciding whether or not the science is effective, but without scientific method and analysis, progress cannot be measured, and the way forward cannot be understood.

BLADE

Blade was originally a ground-up development, with the aim of producing a loudspeaker that could be the ultimate expression of KEF's ideal. The result was a coherent sound source that acoustically resembled a single point across the entire frequency spectrum.

Making its debut at the 2009 Munich High End Show, Concept Blade was the world's first speaker to feature KEF's Single Apparent Source technology – an extension of the Uni-Q concept across the full bandwidth, ensuring matched directivity over a wide area across the full frequency range.

However, with its carbon fibre/balsa wood cabinet construction, Concept Blade would have been too expensive to consider as a production model. During the search for a cabinet material that could allow Blade to be a feasible proposition, further research was conducted into how to improve the system beyond the achievements of Concept Blade.

The first commercially available iterations, Blade and later Blade Two, were thus a feat in electroacoustic technological advancement, which incorporated a fistful of revolutionary technologies that deserve to be listed:

- world's first Single Apparent Source speakers [2]
- powerful vented tweeter with stiffened dome and Tangerine Waveguide [3]
- optimised midrange cone shape with smooth surround, hybrid stiffened cone and nodal drive [4]
- LF drivers with vented coupler, diaphragm decoupling, and force-cancelling configuration
- ultra-low diffraction cabinet made of a stiff glass-reinforced composite material

The latest Blade range consists of two floorstanding models, the Blade One Meta, and its smaller sibling the Blade Two Meta.

THE REFERENCE

The first KEF Reference speaker, Model 104, was launched in 1973. As a direct result of KEF's early adoption of computer aided digital design and measurement, Model 104 represented a new level of performance that could be achieved within the confines of normal rooms. Over the following decades, The Reference would generally be where newest technologies were introduced. As with all KEF ranges, updates and redesigns are only considered when a significant improvement in performance can be delivered.

The Reference range consists of a standmount model (Reference 1 Meta), a pair of floorstanding models (Reference 3 Meta, Reference 5 Meta) and two centre channels (Reference 2 Meta, Reference 4 Meta), making it a flexible range for both two-channel and home theatre applications.

High End 12th Generation Uni-Q with MAT

Over the last 30 years, KEF has developed over 50 examples of the Uni-Q driver array, designed specifically for the range or models in mind. In addition, these 50+ iterations have been grouped into various generations. Within each generation, different Uni-Qs present various levels of performance, with a common technological thread.

Uni-Q is now in its 12th generation, which began with R Series (2018). The new defining technology was the Tweeter Gap Damper. LS50 Meta soon followed, adding Metamaterial Absorption Technology. For the new Blade and The Reference series, KEF engineers took the opportunity to redefine the state of the art and provide a flagship technological example of the latest and greatest 12th generation Uni-Q (Figure 1).

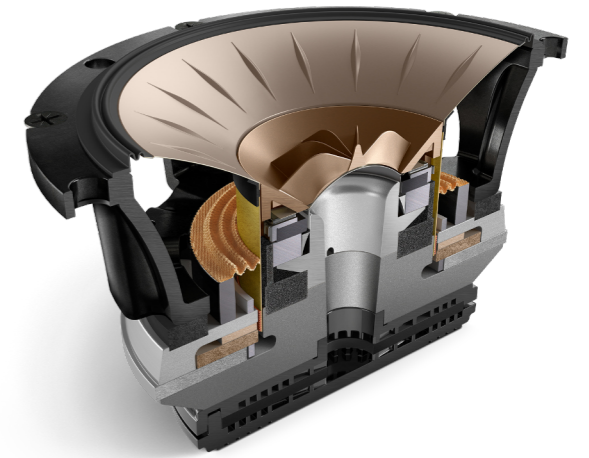

Figure 1. Cut-away of the bespoke high end 12th Generation Uni-Q with MAT

This iteration of Uni-Q presents an advancement in every single aspect of the driver array and every single component has been revised without compromise. Both midrange and tweeter have been designed from the ground-up for this application, ensuring seamless integration of both drivers into one, both acoustically and as a physical package. To do this, several existing and new technologies have been developed and successfully incorporated, achieving levels of performance not previously available.

More information on the concept of Uni-Q, as well as an additional discussion on various common technologies can be found in the 2014 Reference White Paper [1].

High Frequency Driver

The tweeter of this new Uni-Q has undergone significant work. In similar fashion to the LS50 Meta, the introduction of MAT prompted the requirement and opportunity to fully redevelop the tweeter geometry and its components. This not only allows for the acoustical venting of the rear of the tweeter into the

MAT disc, but simultaneously improves motor linearity, as well as the mechanical and acoustical behaviour of its waveguide and its interface with the midrange driver.

Metamaterial Absorption Technology

Metamaterial Absorption Technology (MAT) was first introduced with the LS50 Collection (2020). This maze-like disc (Figure 2) sits behind the tweeter, and its function is to absorb the rear sound wave radiated by the tweeter dome. This wave would otherwise be a source of distortion when being reflected back into the dome.



Figure 2. Metamaterial Absorption Technology (MAT)

The MAT disc comprises 30 channels of differing lengths, formed into tubes sharing an opening on one end and closed on the other. The tubes act as quarter-wave resonators, each tuned to a different frequency with a high Q, which effectively absorb a narrow frequency band and its harmonics (Figure 3). The absorption of these channels is tuned to overlap in frequency, leading to almost 100% absorption across the spectrum above 620Hz - well below the lower threshold of the tweeter's working bandwidth (Figure 4).

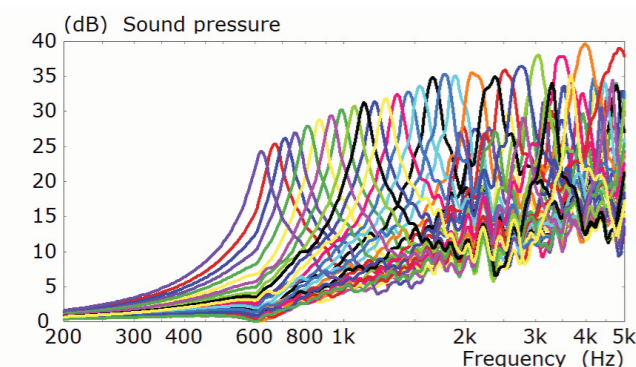

Figure 3. Pressure response at closed end of each absorber chamber

Sitting at merely 11mm deep, it is comparable in performance to a well-designed tapered tube measuring 50cm long. This allows its inclusion into loudspeakers of any size, without requisitioning excessive acoustic volume from the cabinet [5][6].

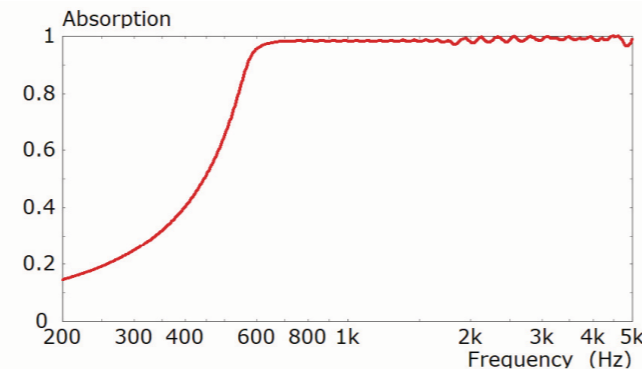

Figure 4. Absorption at the entrance of the conical duct, immediately behind the dome

Coupling MAT to the Tweeter Dome

Of equal importance to the application of MAT is how the back wave is shepherded into the disc. This requires a complete redesign of the area behind the tweeter to form a waveguide with particular characteristics.

Essentially, the acoustic impedance of the waveguide must match that of the opening of the MAT disc to avoid a reflection of the wave within the waveguide back into the tweeter dome. This led to designing a tapered duct, which reduces in diameter towards the disc opening with a conical profile. This inverted conical horn eliminates said reflections, but also fulfils the design requirements of allowing for easier accommodation of the absorber into the driver package and reducing the size of the MAT disc itself.

In addition, the sheer increase of acoustic volume behind the tweeter increases the venting and reduces non-linear distortion related to the spring effect of compressing this rear acoustic volume.

A detailed explanation and the mathematics behind MAT and the coupling technique can be found in the original Audio Engineering Society paper [5].

Tangerine Waveguide Stiffening Ribs

After applying MAT to the LS50 Collection Uni-Q, a low-level residual colouration caused by the deformation of the plastic components of the Tangerine Waveguide and the dome surround support was detected (Figure 5) [7].

To reduce this deformation and the resultant distortion, strengthening ribs were added to the rear of the Tangerine Waveguide (Figure 6). The resultant decrease in displacement is shown in Figure 7.

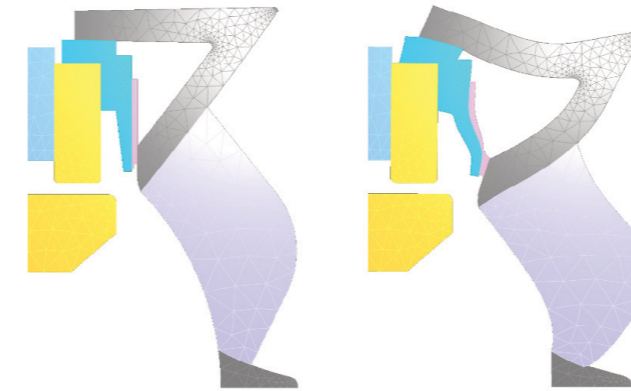

Figure 5. FEA simulation of exaggerated deformation of tangerine waveguide and surround support at 12kHz

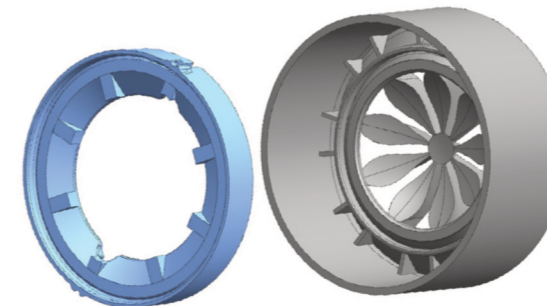

Figure 6. Modified surround support and tangerine waveguide viewed from the rear to show added support ribs

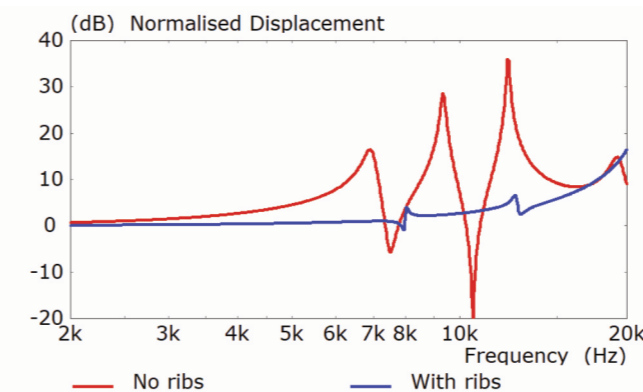

Figure 7. Simulated displacement of tangerine waveguide

HF Motor System

Determining the optimal shape for the opening of the conical waveguide coupling the rear of the tweeter dome to the MAT disc was accompanied by a complete restudy of the tweeter motor system geometry and its electroacoustic performance.

For a description of the steps involved in redeveloping a tweeter motor system to accommodate a wider waveguide through its central pole, while allowing reduced inductance and maintaining similar sensitivity, the reader can refer to the 2020 LS50 Collection white paper [6].

Tweeter Gap Damper

The Tweeter Gap Damper is an established technology for the 12th Generation of Uni-Q - in fact, its development is what defined the move from the 11th Generation.

One of the problems with constructing a combination driver array like Uni-Q is dealing with the constituent parts. There is a narrow channel - an annular gap - between the moving midrange voice coil and the stationary tweeter waveguide. This channel acts as an organ-pipe resonator when excited by the tweeter output. The resonances modify the response of the tweeter, adding a series of glitches that are not present if the gap is closed off - simulating a perfectly smooth waveguide.

The annular gap is necessary to allow the MF cone and voice coil to move. Blocking it by means of a surround or a similar device can result in more detriments than performance benefits. The solution was to create an acoustical cavity packaged between the midrange and tweeter motors, to which this annular gap connected (Figure 8). Adding acoustic damping to this newly created cavity was found to be effective in taming the resonances in the annular gap. The removal of the response glitches was immediately apparent as an improvement in detail clarity (Figure 9).

Further performance improvements were gained through careful shaping of the cavity, and the addition of a second ring of damping material, as per LS50 Meta [6].

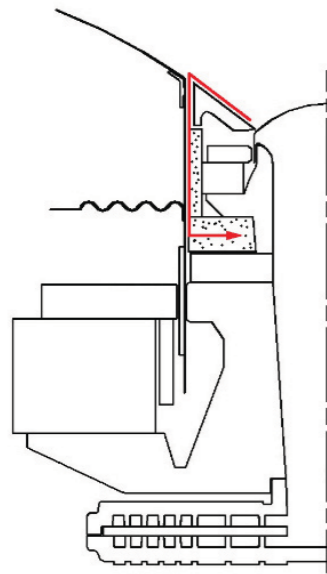

Figure 8. Line drawing showing the mechanism of the Tweeter Gap Damper

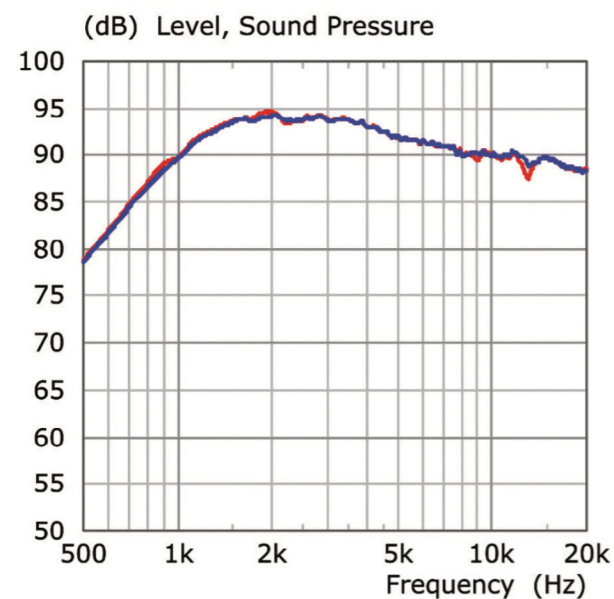

Figure 9. Improvement in frequency response due to the Tweeter Gap Damper

Midrange Driver

The midrange driver has also received significant upgrades and improvements over both the previous Blade and The Reference Uni-Q drivers. As with the high frequency driver, a major aim was to improve motor linearity. This was done through a new motor system, improved suspension and a redesigned spider.

Work was also carried out on a novel, decoupling chassis to reduce unwanted sound emanating from the rim of the chassis.

Ultra-low Distortion MF Motor System

The MF motor system is a complete ground-up design. It has been engineered with the specific goal of reducing distortion due to force factor modulation and voice coil inductance. Additionally, it must now accommodate the conical waveguide connecting the rear of the tweeter diaphragm to the MAT, as well as the Tweeter Gap Damper in the same available space as before. This makes for a much more ambitious packaging endeavour than has previously been attempted in a Uni-Q. Figure 10 shows a section of the magnetic circuit of the tweeter and midrange motors.

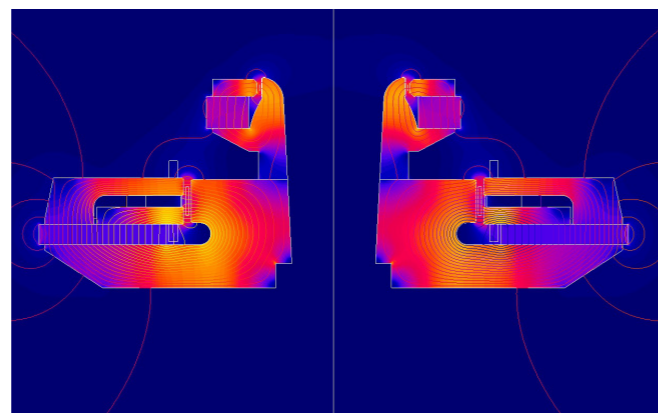

Figure 10. Uni-Q motor system magnetic circuit

The top plate of the MF motor, which together with the central pole forms a long gap in which an underhung voice coil moves, is an unconventional design consisting of two sections separated by an air gap. In the gap between the two sections, and slightly indented, sits a copper ring which is aligned with the centre of the voice coil (Figure 11).

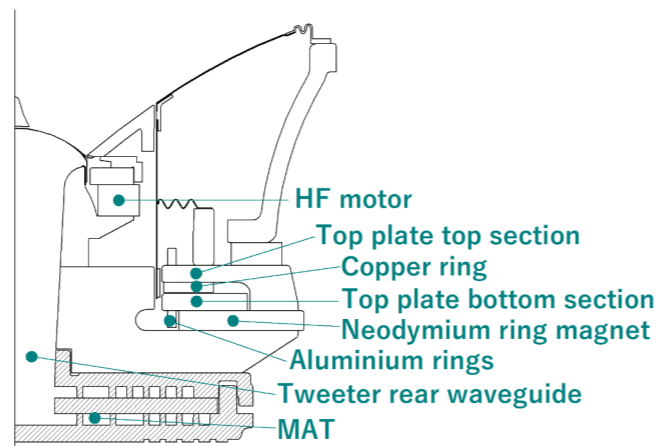

Figure 11. Detail of the MF motor

The motor force factor BL is the product of the flux density B of the magnetic field crossing the voice coil gap, and the voice coil length L dipped in that magnetic field. BL is a function of the voice coil's displacement. Typically, as the voice coil moves away from the gap, BL decreases as the length of coil present in the gap is reduced. This modulates the force applied to the voice coil and thus distorts the signal being reproduced – the way the voice coil reacts to the input signal changes based on coil position. This is a well-understood problem and is one of the main sources of harmonic distortion in drivers.

The new split top plate design focuses the magnetic flux available from the motor's Neodymium ring magnet away from the centre of the voice coil towards its ends. This creates a magnetic flux density profile $B(x)$ that decreases around the voice coil's rest position and is shaped like an 'M' (Figure 12).

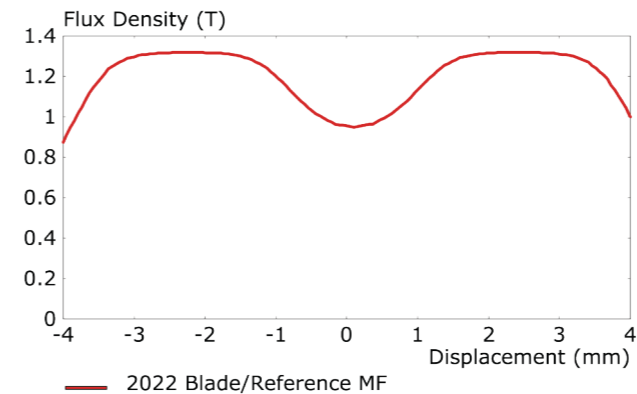

Figure 12. New motor's $B(x)$

The resulting $BL(x)$ is thus flatter along the voice coil's excursion of +/- 2mm compared to previous designs (Figure 13). A flatter $BL(x)$ means the force applied to the voice coil will more closely be able to follow the applied signal.

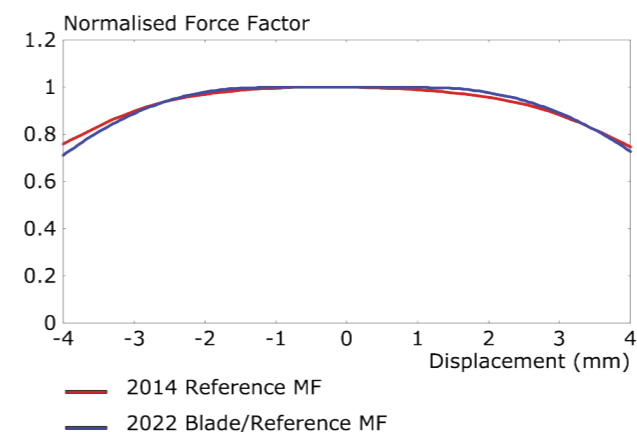

Figure 13. Comparison of $BL(x)$

As AC current flows through the voice coil, an alternating magnetic field is produced. Its strength is dependent on the inductance of the voice coil, with higher inductance producing a stronger field. This AC magnetic field is conducted by the steel in the motor system, superimposed on the DC field due to the permanent magnet.

Steel is highly magnetically non-linear, and the superimposed AC magnetic field causes some of the magnetic domains within the steel to reorient. This results in a shift in the permeability of the steel, leading to modulation of the DC magnetic field, and a modulation of the motor BL . These sudden shifts in the magnetic domains are also picked up as induced voltage signals in the voice coil, corrupting the music signal. This behaviour is highly hysteric, and the generated distortion has a particularly unpleasant characteristic.

This is not the only issue, however. Inductance itself varies with the position of the voice coil - where the voice coil is constantly being pulled towards where inductance is highest. This is known as 'reluctance force' and is highly non-linear as it is proportional to the square of the current flowing through the voice coil.

The new Uni-Q tackles these issues in two ways. Firstly, it is possible to reduce the impact of the voice coil's magnetic field by using a stronger permanent magnet in the motor. The stronger the magnet (all else being equal), the lesser the effect of the voice coil's magnetic field.

To achieve this, an extremely strong Neodymium ring magnet has been utilised. Neodymium magnets exhibit a far higher energy product than Alnico magnets (sintered Alnico exhibits in the region of 10-88kJ/m³, whereas sintered Neodymium magnets are in the region of 200-400kJ/m³).

The motor geometry has been additionally optimised to increase saturation of the steelwork to reduce its magnetic permeability, thus decreasing its susceptibility to be magnetised by the voice coil's AC magnetic field.

Secondly, in addition to two Aluminium rings sitting on either side of the voice coil gap, a wide copper insert has been placed within the air gap created by the split top plate.

Conductive regions like these couple to the voice coil and allow the flow of induced current through them. This then produces an opposing magnetic field to the

one created by the voice coil, further reducing the ability of the voice coil to magnetise the motor steel.

This arrangement is particularly advantageous, however. Sitting right in the middle of the two top plate sections and aligned with the voice coil's centre along its length, the conductive copper ring's effect on lowering distortion is much greater, and symmetrical with displacement. Careful determination of its dimensions serves to maximise its effect with minimum use of material.

Figure 14 shows a visualisation of the flux density modulation regions present in the steelwork of the motor near the voice coil gap at a representative frequency. It is worth mentioning this performance is already class leading. However, a considerable further reduction can be observed when the optimised conductive regions of Aluminium and Copper are added to the motor.

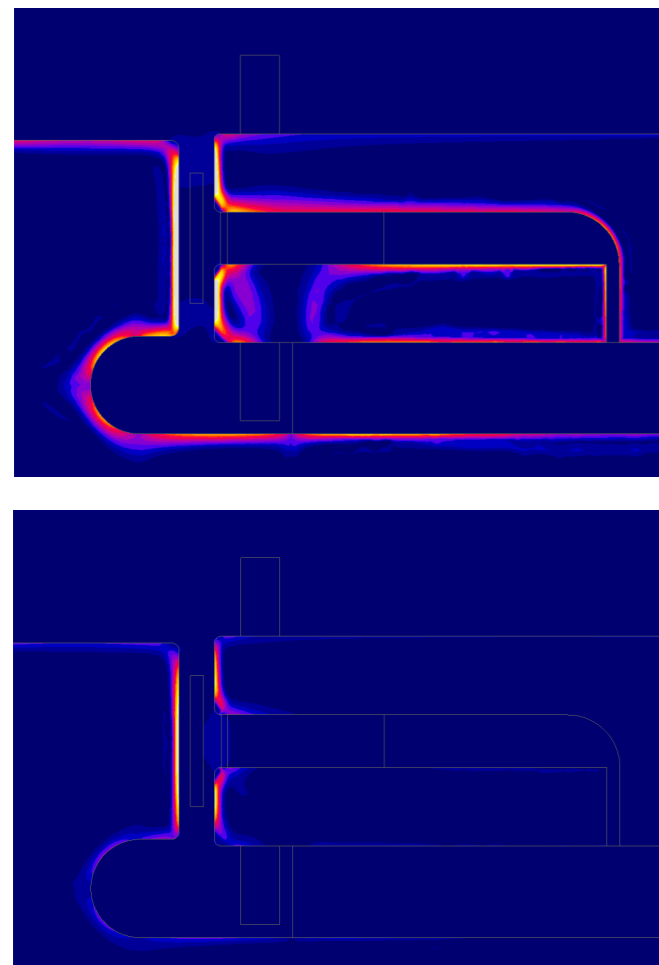

Figure 14. MF flux density modulation at 500Hz without conductive regions (top) and with conductive regions (bottom)

Figure 15 shows the overall reduction in voice coil inductance across frequency, whilst Figure 16 shows the

reduction in Total Harmonic Distortion in the midrange between the previous Reference 1 and the new Reference 1 Meta.

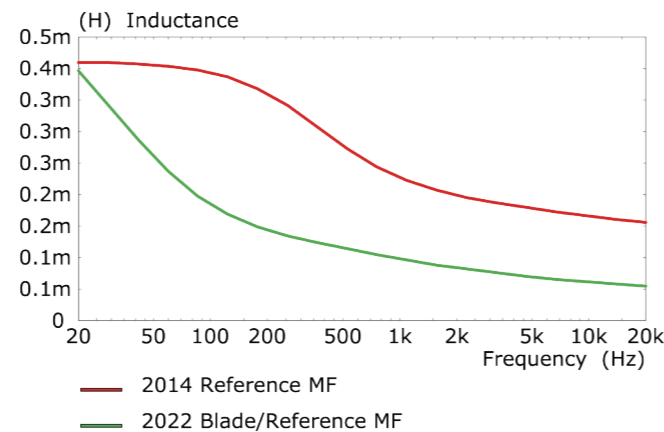

Figure 15. MF voice coil inductance improvement

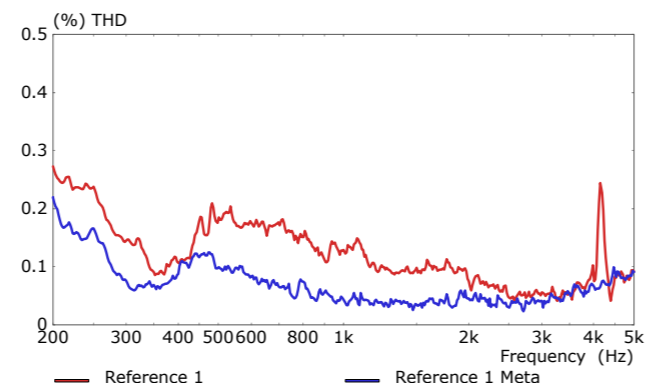

Figure 16. Comparison of THD (%) of Reference 1 (red) and Reference 1 Meta (blue) at 90dB SPL @ 1 metre

Finally, the copper ring efficiently dissipates heat away from the voice coil. This reduces thermal compression of the signal whilst improving efficiency.

MF Surround and Spider

For the new Uni-Q, both the surround and the spider have been redesigned to improve their linearity and reduce harmonic distortion.

As the spider (suspension) moves back and forth with the voice coil, a dip in the driver frequency response develops. This occurs at the spider's resonant frequency, which is dependant on its stiffness and mass. It is very easy for this resonance to sit in the passband of a midrange driver. Shifting it out of this region is challenging since it requires a very low mass while still allowing the driver to move its full linear excursion.

The Uni-Q redesign has allowed the reduction of the spider's width to merely 0.69cm (0.27"). Decreasing the

width decreases the mass of the spider, which has the effect of increasing the resonant frequency out of the passband.

Figure 17 shows a comparison of the simulated frequency response of the 2014 Reference MF driver and the new MF driver. The disappearance of the dip at 650 Hz caused by the spider resonance is clearly apparent.

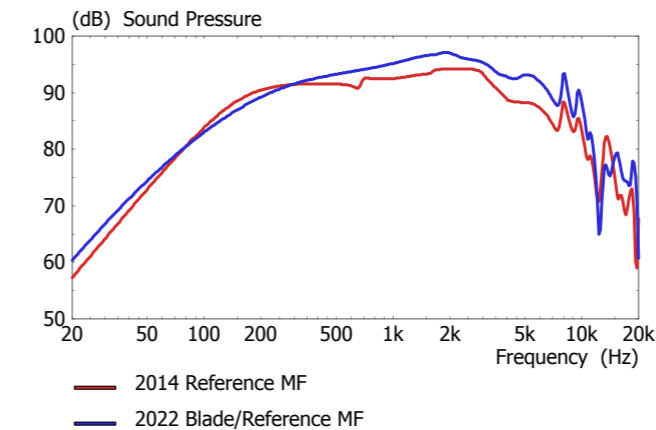

Figure 17. MF frequency response showing the spider 'dip' deletion

One of the quintessential characteristics of Uni-Q is its uninterrupted tweeter waveguide. To achieve this ideal, the surround must be as flat as possible to allow for smooth propagation of the sound wavefront travelling out along the tweeter waveguide. Any irregularity or obstacle would simply interrupt and smear the wavefront. At the same time, the surround can be an important source of non-linear distortion. As the surround moves with cone displacement, it deforms. As its shape changes, its stiffness, radiating area and moving mass vary.

For this design iteration, the challenge was to increase the midrange excursion whilst maintaining linear behaviour. At the same time, no obstacle should be presented to the tweeter wavefront. The profile of the surround was examined in detail to improve symmetrical stiffness along the cone's displacement and, for the first time, research was carried out to develop a surround that presented minimum variation of its mass and radiating area as it deforms with displacement.

Figure 18 shows the normalised variation of the surround's radiating area Sd and moving mass Mmd with cone displacement x . The reduction in variation in the new design is clear in both metrics.

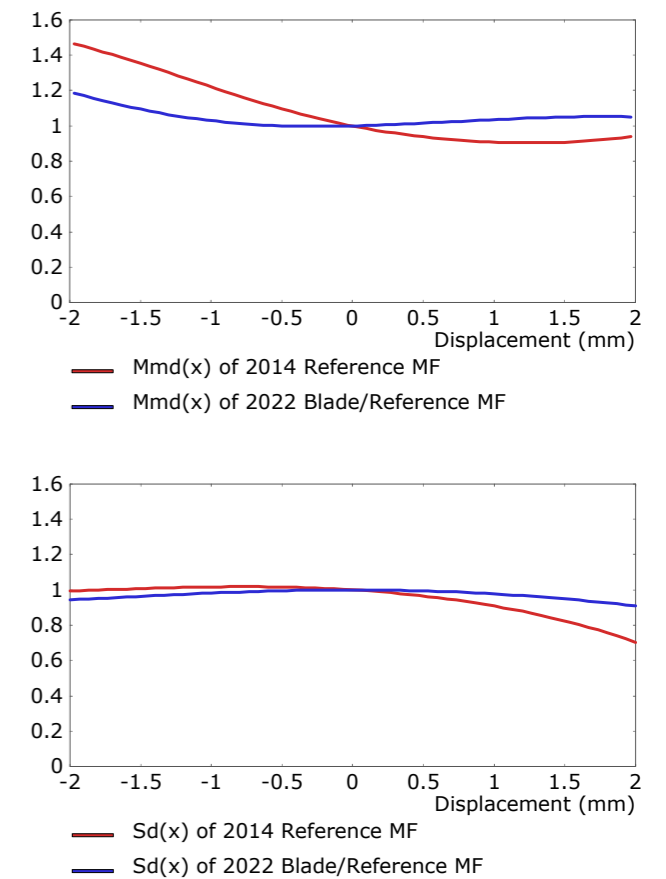

Figure 18. Variation of Mmd (top) and Sd (bottom)

The design of both components together ensures that the cone excursion is linear in both directions, reducing distortion of the signal even at high output levels.

Flexible Decoupling Chassis

Rigid affixing of the driver to the cabinet allows the driver to directly excite the cabinet. Since cabinets are usually comprised of large flat sheets of material with limited stiffness and mass, this can result in the walls of the cabinet being easily excited. Since the cabinet walls have a large surface area, this excitation can efficiently transform into unwanted acoustic radiation.

Much can be achieved by designing the cabinet to be stiff, heavy, and well damped, to avoid transmitting this vibration on as sound.

KEF has been experimenting with driver decoupling ever since Model 105.2 in 1979. For this loudspeaker, KEF developed a decoupling method colloquially known as the 'KEF mount.' It consisted of a metal apparatus with a rubber grommet screwed into the cabinet. The driver was in turn mounted to the apparatus. This decoupled

the driver from the cabinet. Work was also carried out to ensure the resonant frequency of the decoupling matched the resonance of the speaker in the cabinet to limit the effect on the frequency response.

A common decoupling method involves mounting the driver onto the cabinet through a soft compliant element under the chassis rim. Whilst this approach does reduce transmission of vibration into the cabinet, it comes with its own drawbacks. Since the motor and chassis assembly is suspended, when excited by the force of the voice coil, it is allowed to displace substantially over the driver's resonance frequency. This increased displacement of the chassis rim, multiplied by its large area relative to the driver's diaphragm, results in considerable unwanted acoustic radiation, which, to some extent, defeats the purpose of the decoupling method (Figure 19).

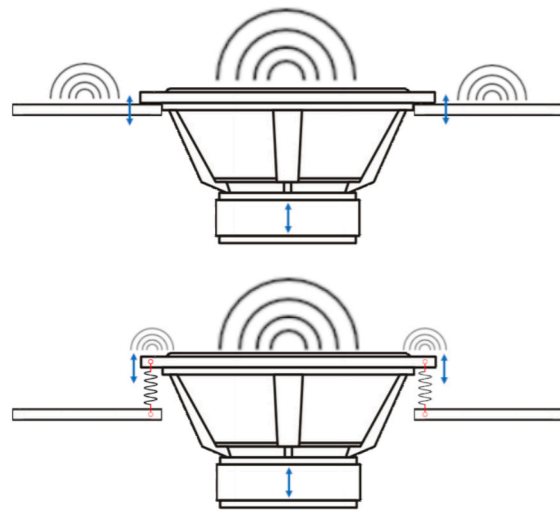

Figure 19. Illustrations of vibration caused as the voice coil moves when a driver is coupled to (top) and decoupled from (bottom) the cabinet

This new Uni-Q approaches the issue slightly differently, building decoupling into the chassis itself (Figure 20). The decoupling separates the motor assembly from the rest of the driver, and thus the cabinet (Figure 21). This reduces the sprung mass and allows for better control of the decoupling mechanism. The motor is suspended and connected to the chassis through eight flexible spring elements integrated into the chassis moulding. Where the spring elements end the rigid chassis begins and pads of a suitable damping material provide energy dissipation in between.

Figure 22 shows a comparison of measured point laser velocity on a speaker baffle when excited by a sinusoidal chirp fed into the midrange driver, using three different chassis configurations. For the red curve the rigid Aluminium chassis from the 2014 Reference line is used.

For the blue curve the new decoupled chassis is used but no damping has been added. Finally, for the green curve suitable damping has been added to the decoupled chassis, as implemented on the new Uni-Q.

The effect of the Flexible Decoupling Chassis on the vibration of the cabinet is readily apparent. Two phenomena are taking place. Firstly, a peak in vibration associated with the entire mass of the driver resonating against the cabinet is 'split' into two peaks out of the midrange frequency band, due to the sprung mechanism decoupling the mass of the MF motor. Secondly, the peaks in vibration are heavily reduced by adding damping material in parallel with the sprung mechanism and thus dissipating energy. The net result is much lower excitation of the cabinet across the frequency range covered by the midrange driver.

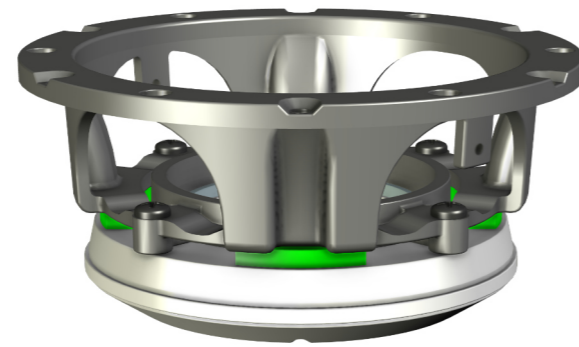

Figure 20. Chassis and upper motor section showing Flexible Decoupling Chassis arrangement with decoupling material highlighted in green

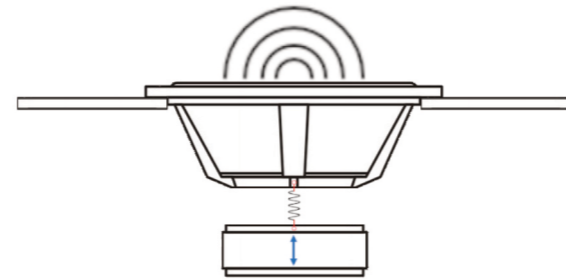

Figure 21. Illustration of the decoupling mechanism

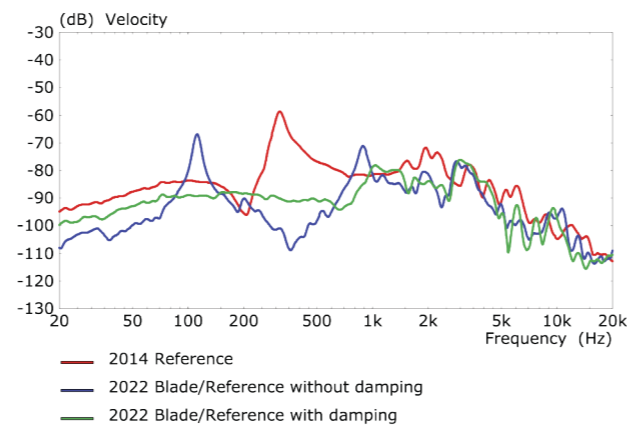

Figure 22. Effect of chassis decoupling on baffle vibration

Crossover

Since the introduction of the original Blade, the engineers at KEF R&D have been working on the continuous development of new measuring techniques and in-house simulation software to further improve their understanding of how a speaker design performs. In both Blade and The Reference, there was an opportunity to completely redesign the crossover networks that integrate the output of the different drivers, taking full advantage of the increased capabilities of the 12th generation Uni-Q specifically designed for this application.

Firstly, the higher excursion and increased linearity of the MF driver afforded the engineers more flexibility to specifically improve its acoustic integration with the LF drivers.

This prompted a re-study of the off-axis radiation of the LF and MF Blade drivers and their complex interaction around the crossover region, both in the horizontal and vertical directions. As a result, the MF driver polarity has been inverted and the filter transfer functions have been designed to prioritise smoothness in all directions and reduce any troughs and peaks previously appearing in the speaker's off-axis response around the crossover region. Figure 23 shows a comparison of the horizontal dispersion of Blade Two and Blade Two Meta as a contour map, where the improvement in smoothness and the directivity taper are apparent.

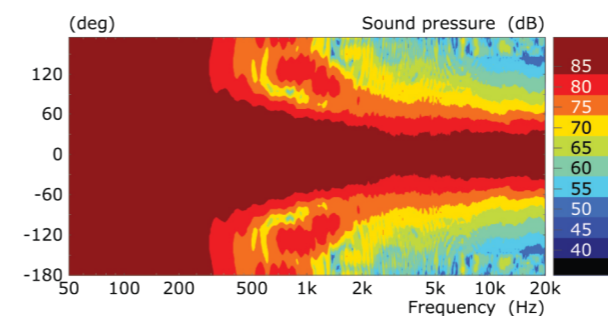
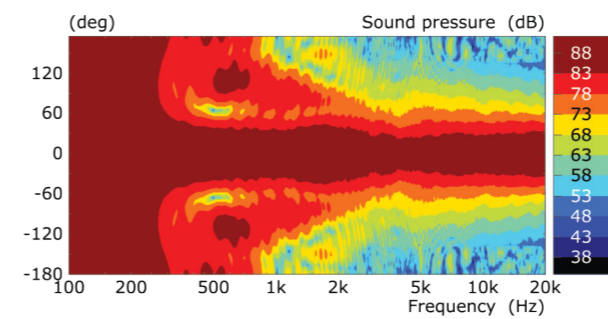

Figure 23. Horizontal dispersion of Blade Two (top) vs. Blade Two Meta (bottom)

Secondly, the improved break-up behaviour of the midrange and the improved lower-end response and lower distortion of the tweeter allowed the redesign of the MF-HF crossover, to better integrate the radiation of both drivers and further smooth the system's off-axis response.

In passive crossover design the crossover cut-off frequency and filter slopes between the midrange and the tweeter are typically chosen to protect the tweeter from generating high distortion and overheating. In a speaker incorporating a Uni-Q, however, the crossover is an integral part of matching the directivity of the midrange and the tweeter, so that the transition between the two is seamless to the ears.

Figures 24 and 25 (following page) show an example speaker with a Uni-Q and a crossover set at 2 kHz and 4 kHz, using the same filter slopes (acoustic 4th order Linkwitz-Riley). The on-axis frequency response is flat and is the same in both cases. A second curve, the power average, is calculated by averaging the speaker response in all directions. This curve loses its continuity and smoothness in the case where the crossover frequency is 4 kHz, as the midrange becomes more directional than the tweeter. The directivity of the midrange and the tweeter in the Uni-Q is not matched anymore. This demonstrates the principle of directivity matching in a Uni-Q driver array to provide a smooth dispersion across the frequency spectrum. This emphasises how this is possible only when both drivers already have a superbly smooth and wide frequency response, as is the case with this Uni-Q.

Lastly, research conducted during the development of The Reference (2014), R Series (2018) and LS50 Meta (2020) has provided evidence for an improved choice of inductors, capacitors and resistors that directly results in lower system distortion and improved signal integrity.

All these improvements in the crossover together have helped the engineers achieve a substantially smoother frequency response in any direction, free of artifacts and discontinuities and clean of resonances for all speakers in the Blade and The Reference series. The result has been a notable increment in stereo image stability, realism and spatial depth, and in preserving the true timbral qualities of a musical signal within any listening room in which the speakers are positioned.

Summary

Simply rebuilding a high-end Uni-Q around the new 12th generation technology additions would have garnered improvements, but this is not the way KEF operates. Prior research and development help to inform some of the ways to improve performance, but the requirements and expectations of what a KEF loudspeaker range should achieve must always be central – and never has that been truer.

Even after 60 years, the same guiding philosophy and dedication to excellence in engineering laid down by Raymond Cooke continue to lead the march forward. These new incarnations of Blade and The Reference are the reward for maintaining that approach, a ground-up redesign representing the pinnacle of performance.

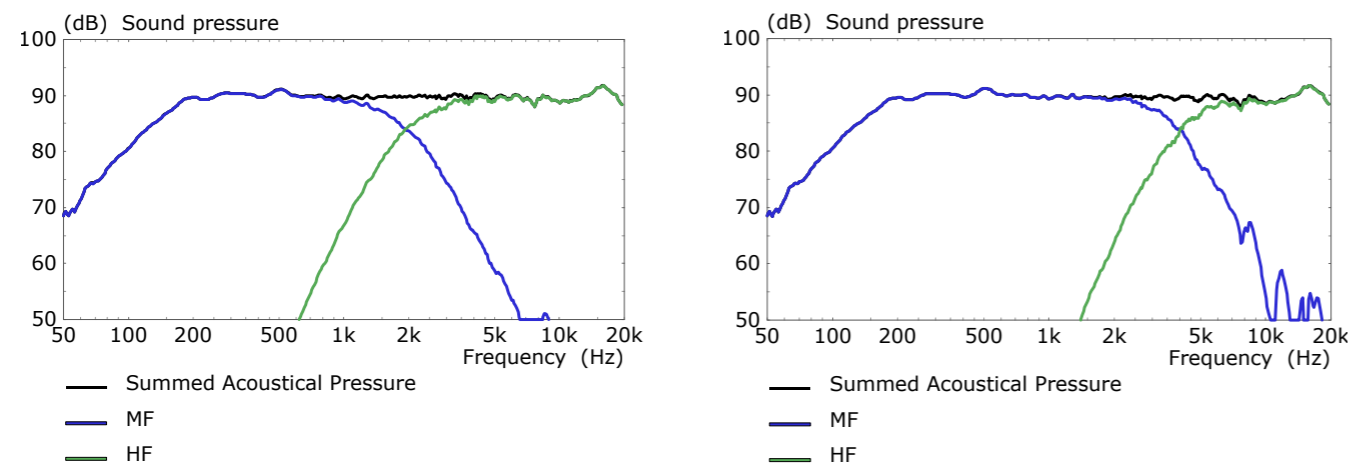

Figure 24. Effect of crossover frequency on Uni-Q driver array's frequency response when crossover is at 2kHz (left) and 4kHz (right)

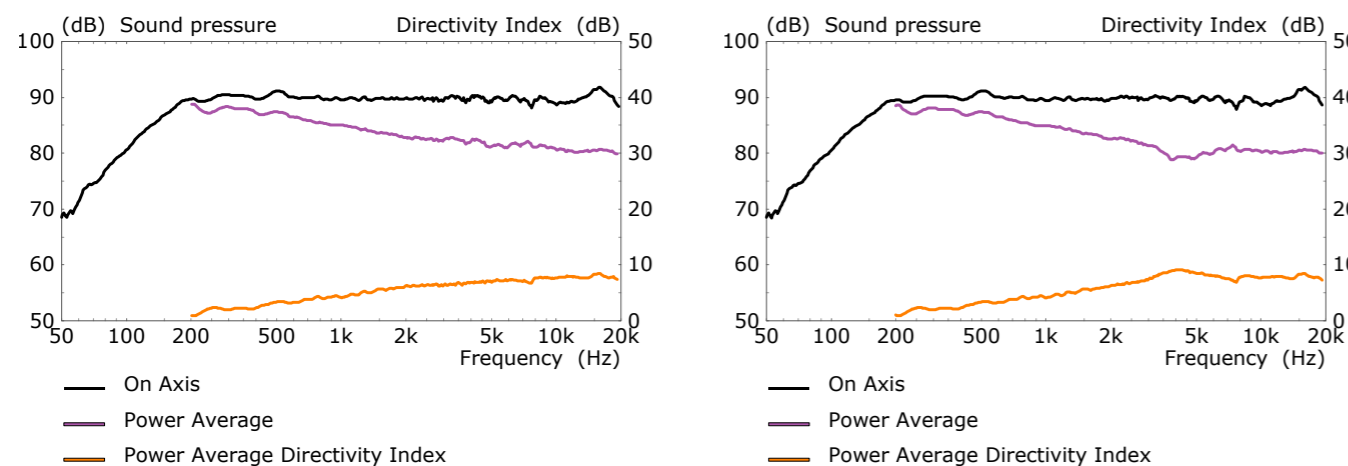

Figure 25. Effect of crossover frequency on Uni-Q driver array's power average and directivity index when crossover is at 2kHz (left) and 4kHz (right)

Appendix (BLADE)

Single Apparent Source

In traditional loudspeaker designs, sound is radiated from different sources covering the audible frequency spectrum. As these sources are separated in space and placed in different positions, this causes issues in the way sound arrives at the listener - difference in direction, timbral changes due to cancellation and interference between sources, and poor transient alignment.

Uni-Q tackles these issues in the midrange and high frequencies. As a coincident source, the sound from the two constituent radiating elements travels the same path to the ear - meaning sound emanated by both sources at the same time across the frequency region in which they crossover will not interfere destructively and form regions of attenuated output around the speaker. According to Linkwitz, this arrangement enables the timbral properties of reflected sound in most rooms to be very similar to the direct sound, allowing the human brain to filter out the room much more effectively [8].

With Single Apparent Source, the concept of Uni-Q is further extended to the LF drivers of a three-way system design. It has been found that large public address horns, given enough distance, create an observed point source due to the wave-front curvature. Single Apparent Source begins to utilise this idea by positioning four identical LF drivers equidistant around the Uni-Q in both the horizontal and vertical axes. At a distance, this creates an apparent acoustic source for the four LF drivers.

Completing the puzzle is the relationship between the LF drivers and Uni-Q array. The LF-only apparent source sits on the same axis horizontally and vertically as the Uni-Q. As the axial position of the two acoustic centres are exceptionally close together, within a fraction of the wavelengths generated by the LF drivers, at a distance these two sources appear to merge, creating a single apparent source.

Force Cancelling

An additional benefit of Single Apparent Source is that the LF driver arrangement creates a force-cancelling effect. The science behind force-cancelling is a major topic in the KC62 white paper [9], but to summarise,

without a force-cancelling configuration driver motion creates an equal opposing force that acts upon the cabinet, causing coloration.

With Blade, the LF drivers are securely bonded together, back-to-back, through a combination of threaded bolts and the same bituminous material used in Constrained Layer Damping, as found in many other KEF loudspeakers. The reactive force of one is cancelled out by the other member of the pair (Figure 26).

In fact, when demonstrating Blade, many KEF employees will place a coin standing upright at the apex of the cabinet, followed by playing wide bandwidth music at high output. Due to the vanishingly low resonance of the cabinet, the coin will continue to stay upright.

Combined with the curved cabinet construction and the glass reinforced composite material used, Blade requires minimum bracing, allowing for a maximum of available acoustic volume.

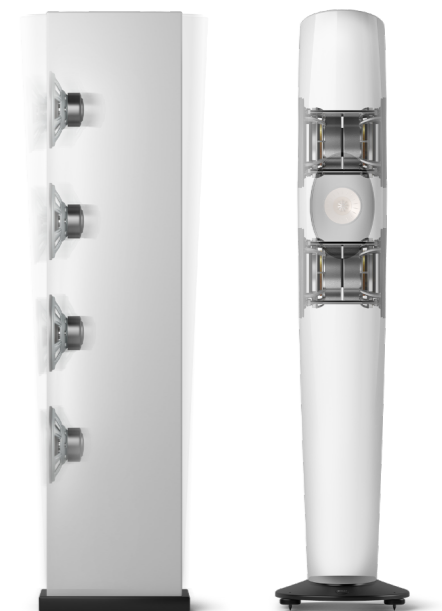

Figure 26. Illustration of reactive force on a traditional cabinet and the lack thereof in Blade's force-cancelling arrangement

Cabinet Design

KEF has long worked to combine acoustics and design in such a way that the two become more than partners - aesthetics and performance are not mutually exclusive endeavours, and the shape can absolutely work to the benefit of performance.

The performance of the Single Apparent Source concept is directly related to how tightly the drivers are packed

together on all axes. This necessitates a slim cabinet profile to position the side-firing LF drivers as close to the Uni-Q array as possible.

The original industrial design was carried out by KEF's R&D and Product Planning & Design teams, in conjunction with Eric Chan of ECCO Design in New York. The parabolic shape was inspired by Bird in Space, a series of 1920s sculptures by Romanian-born Constantin Brancusi. The curved form is not only slim, helping to maximise the potential of the Single Apparent Source concept, but is also free of sharp edges.

Diffraction is related to the relationship between the wavelength of a frequency and the distance between sound source and an irregularity - say a cabinet corner. If the wavelength is sufficiently longer than this distance, diffraction is essentially minimal [10]. If Blade were just as slim but with a rectilinear box construction, considerable diffraction effects would occur, albeit at higher frequencies. The fact that Blade is curved means that it has innumerable corners with infinitesimally small distances between them, greatly reducing the negative effects of diffraction.

KEF pioneered the use of separate enclosures for different drivers when first employing the Total System Design approach with Reference Model 105 in 1977. The idea has certainly not been abandoned - instead, the compartmentalisation is internalised within the cabinet of Blade (and The Reference). Uni-Q sits within its own can structure, with a finely tuned internal volume for optimal acoustic loading. The two pairs of LF drivers also sit within their own compartments. These are of equal volume, and each is served by its own bass port. The size and shape of these compartments have been calculated to push standing wave resonances well above the working bandwidth of the bass drivers.

References

- [1] KEF Research and Development, "THE REFERENCE White Paper", 2014
- [2] M. Dodd and J. Ocle-Brown, "Design of a Coincident Source Driver Array with a Radial Channel Phase-Plug and Novel Rigid Body Diaphragms", 127th Audio Eng. Soc. Convention, 2009
- [3] M. Dodd and J. Ocle-Brown, "A New Methodology for the Acoustic Design of Compression Driver Phase Plugs with Radial Channels", 125th Audio Eng. Soc. Convention, 2008
- [4] M. Dodd, "Optimum Diaphragm and Waveguide Geometry for Coincident source Drive Units", 121st Audio Eng. Soc. Convention, 2006
- [5] S. Degraeve and J. Ocle-Brown, "Metamaterial Absorber for Loudspeaker Enclosures", 148th Audio Eng. Soc. Convention, 2020
- [6] KEF Research and Development, "LS50 Collection White Paper", 2020
- [7] KEF Research and Development, "R Series White Paper", 2017
- [8] S. Linkwitz, "Room Reflections Misunderstood?", 123rd Audio Eng. Soc. Convention, 2007
- [9] KEF Research and Development, "KC62 White Paper", 2021
- [10] D.A. Barlow, "The Sound Output of Loudspeaker Cabinet Walls", 50th Audio Eng. Soc. Convention, 1975

BLADE

Model Information, Specifications and Measurements



Blade One Meta

Three-way Single Apparent Source Loudspeaker

Blade One Meta is the flagship model of the range. Featuring the Single Apparent Source driver layout, Blade extends the benefits of Uni-Q across the entire audio range.

Owing to its large cabinet size and use of four 225mm (9 in.) bass drivers, it is capable of effortlessly producing high output levels into the lower frequencies, alongside a detailed top end and lifelike midrange. A true statement of sound.

Technical Specifications

System	Three-way bass reflex Single Apparent Source
Drive units	Uni-Q Driver Array: HF: 25 mm (1 in.) aluminium dome with MAT MF: 125 mm (5 in.) aluminium cone Bass Drivers: LF: 4 x 225mm (9 in.) aluminium cone, force-cancelling
Frequency range free-field (-6dB)	27Hz - 45kHz
Typical in-room bass response (-6dB)	20Hz
Frequency response (±3dB)	35Hz - 35kHz
Crossover frequencies	350Hz, 2kHz
Recommended amplifier power	50 - 400W
Sensitivity (2.83V/1m)	88dB
Harmonic distortion 2 nd & 3 rd harmonics (90dB, 1m)	<0.5% 40Hz and above <0.2% 200Hz - 2kHz <0.1% 2kHz - 20kHz
Maximum output (Peak sound pressure level at 1m with pink noise)	117dB
Impedance	4 Ω (min. 2.8 Ω)
Weight	57.2 kg (126 lbs)
Dimensions with plinth (H x W x D)	1590 x 363 x 540 mm (62.5 x 14.3 x 21.2 in.)

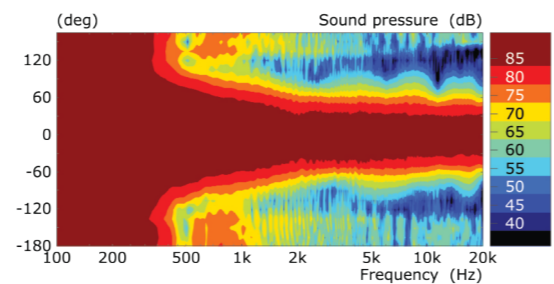
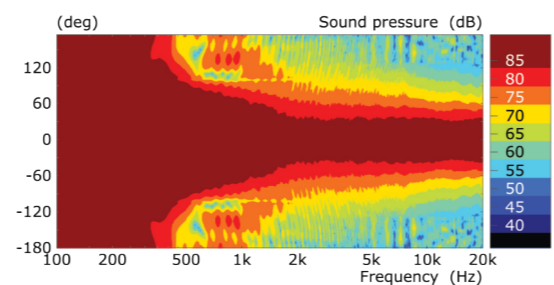
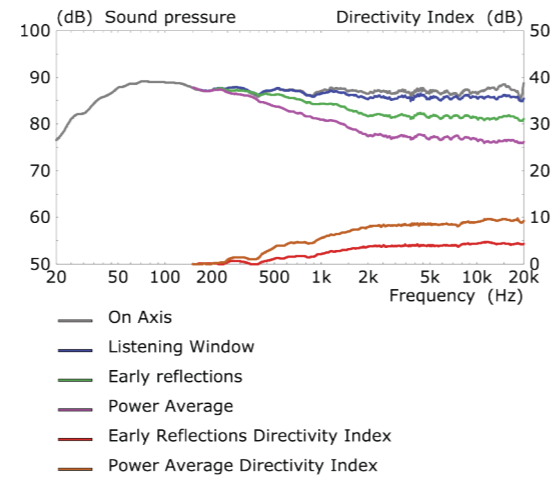

Blade One Meta Spinorama (top) and dispersion plots - horizontal (middle) and vertical (bottom)

Blade Two Meta

Three-way Single Apparent Source Loudspeaker

Perfect for smaller rooms, but when nothing but the absolute best will suffice. Blade Two Meta utilises the exact same sized Uni-Q as its larger sibling, pairing it with four 165mm (6.5 in.) bass drivers

Just as with Blade One Meta, Blade Two Meta excels in both stereo and home theatre applications - the aim is always the same: to reproduce the recorded sound as accurately as possible.

Technical Specifications

System	Three-way bass reflex Single Apparent Source
Drive units	Uni-Q Driver Array: HF: 25 mm (1 in.) aluminium dome with MAT MF: 125 mm (5 in.) aluminium cone Bass Drivers: LF: 4 x 165mm (6.5 in.) aluminium cone, force-cancelling
Frequency range free-field (-6dB)	30Hz - 45kHz
Typical in-room bass response (-6dB)	25Hz
Frequency response (±3dB)	33Hz - 35kHz
Crossover frequencies	450Hz, 2.2kHz
Recommended amplifier power	50 - 400W
Sensitivity (2.83V/1m)	86dB
Harmonic distortion 2 nd & 3 rd harmonics (90dB, 1m)	<0.5% 40Hz and above <0.2% 200Hz - 2kHz <0.1% 2kHz - 20kHz
Maximum output (Peak sound pressure level at 1m with pink noise)	116dB
Impedance	4 Ω (min. 3.2 Ω)
Weight	35.3 kg (77.8 lbs)
Dimensions with plinth (H x W x D)	1461 x 338 x 475 mm (57.5 x 13.3 x 18.7 in.)

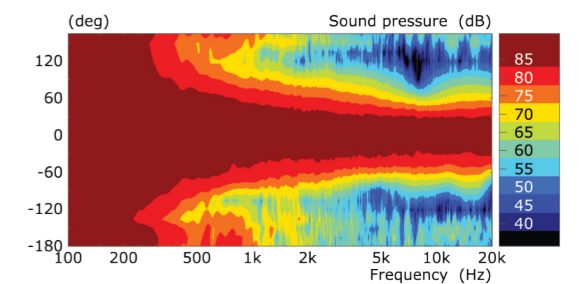
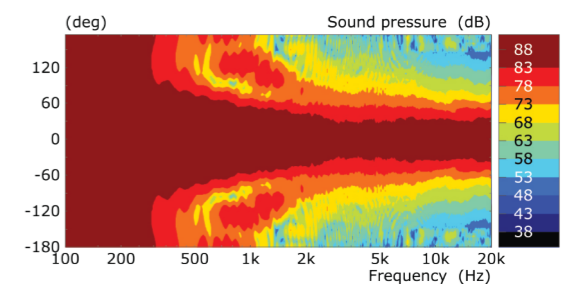
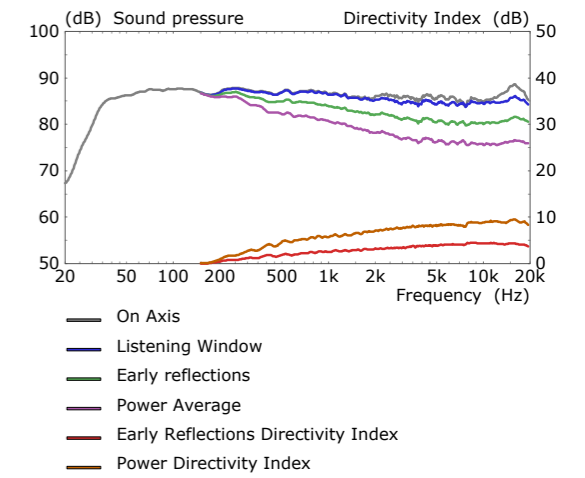

Blade Two Meta Spinorama (top) and dispersion plots - horizontal (middle) and vertical (bottom)

THE REFERENCE

Model Information, Specifications and Measurements



Reference 5 Meta

Three-way Floorstanding Loudspeaker

Leading the range, Reference 5 Meta is KEF's most accomplished speaker that uses a modified D'Appolito layout, bettered only by Single Apparent Source. Selectable port tubes allow for the fine-tuning of the speaker's bass performance depending on room size and boundary proximity.



Technical Specifications

System	Three-way bass reflex
Drive units	Uni-Q Driver Array: HF: 25 mm (1 in.) aluminium dome with MAT MF: 125 mm (5 in.) aluminium cone Bass Drivers: LF: 4 x 165mm (6.5 in.) aluminium cone
Frequency range free-field (-6dB)	Long port: 32Hz - 45kHz Short port: 35Hz - 45kHz
Typical in-room bass response (-6dB)	25Hz
Frequency response (±3dB)	40Hz - 35kHz
Crossover frequencies	450Hz, 2.1kHz
Recommended amplifier power	50 - 400W
Sensitivity (2.83V/1m)	88dB
Harmonic distortion 2 nd & 3 rd harmonics (90dB, 1m)	<0.5% 40Hz and above <0.2% 200Hz - 2kHz <0.1% 2kHz - 20kHz
Maximum output (Peak sound pressure level at 1m with pink noise)	116dB
Impedance	4 Ω (min. 3.2 Ω)
Weight	60.2 kg (132.7 lbs)
Dimensions with terminals (H x W x D)	1350 x 205 x 462 mm (53.1 x 8.1 x 18.2 in.)
Dimensions with plinth and terminals (H x W x D)	1402 x 323 x 467 mm (55.2 x 12.7 x 18.4 in.)

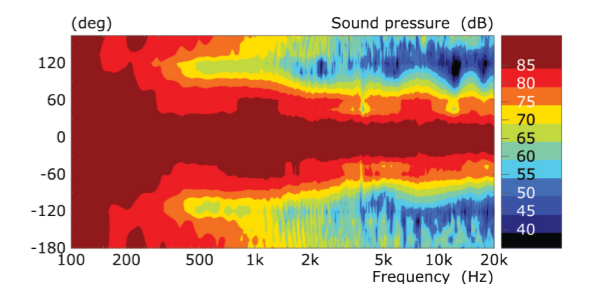
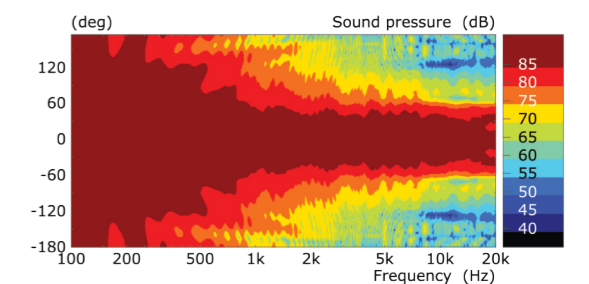
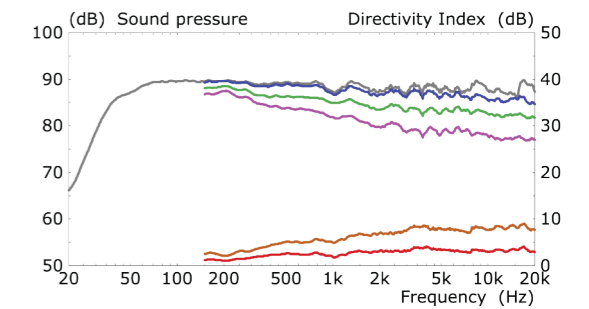

Reference 5 Meta Spinorama (top) and dispersion plots - horizontal (middle) and vertical (bottom)

Reference 3 Meta

Three-way Floorstanding Loudspeaker

The smaller of the two Reference floorstanders, Reference 3 Meta matches its Uni-Q with a pair of 6.5 in. bass drivers. Whilst less of a monolith than its bigger brother, Reference 3 Meta is more than capable of filling all but the largest of listening rooms.



Technical Specifications

System	Three-way bass reflex
Drive units	Uni-Q Driver Array: HF: 25 mm (1 in.) aluminium dome with MAT MF: 125 mm (5 in.) aluminium cone Bass Drivers: LF: 2 x 165mm (6.5 in.) aluminium cone
Frequency range free-field (-6dB)	Long port: 35Hz - 45kHz Short port: 38Hz - 45kHz
Typical in-room bass response (-6dB)	28Hz
Frequency response (±3dB)	43Hz - 35kHz
Crossover frequencies	450Hz, 2.1kHz
Recommended amplifier power	50 - 300W
Sensitivity (2.83V/1m)	86dB
Harmonic distortion 2 nd & 3 rd harmonics (90dB, 1m)	<0.5% 40Hz and above <0.2% 200Hz - 2kHz <0.1% 2kHz - 20kHz
Maximum output (Peak sound pressure level at 1m with pink noise)	113.5dB
Impedance	4 Ω (min. 3.2 Ω)
Weight	51.3 kg (113.1 lbs)
Dimensions with terminals (H x W x D)	1155 x 205 x 462 mm (45.5 x 8.1 x 18.2 in.)
Dimensions with plinth and terminals (H x W x D)	1207 x 323 x 467 mm (47.5 x 12.7 x 18.4 in.)

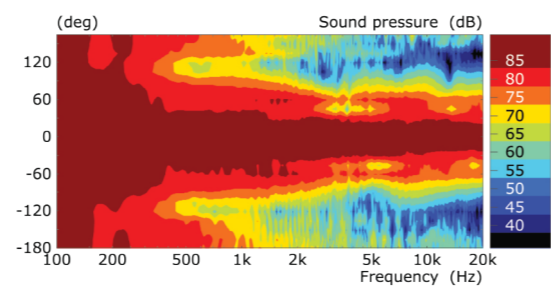
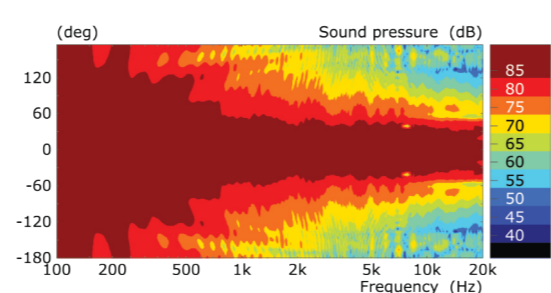
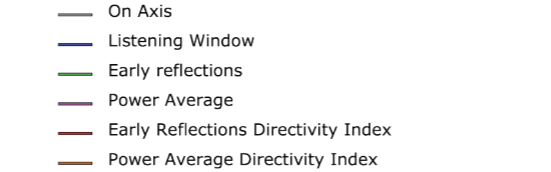
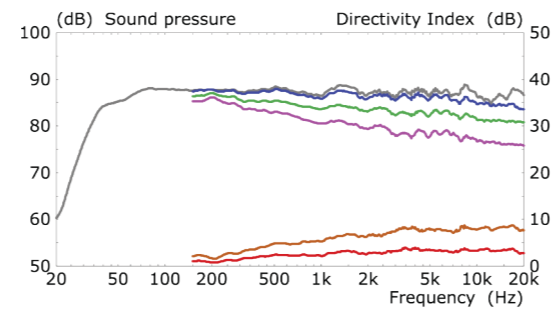

Reference 3 Meta Spinorama (top) and dispersion plots - horizontal (middle) and vertical (bottom)

Reference 1 Meta

Three-way Standmount Loudspeaker

Thanks to the inclusion of Uni-Q, it is possible to develop a standmount loudspeaker that can truly compete with larger floorstanders. This three-way design reproduces clean, accurate sound beyond its size, throughout its bandwidth.



Technical Specifications

System	Three-way bass reflex
Drive units	Uni-Q Driver Array: HF: 25 mm (1 in.) aluminium dome with MAT MF: 125 mm (5 in.) aluminium cone Bass Drivers: LF: 165mm (6.5 in.) aluminium cone
Frequency range free-field (-6dB)	Long port: 37Hz - 45kHz Short port: 40Hz - 45kHz
Typical in-room bass response (-6dB)	30Hz
Frequency response (±3dB)	45Hz - 35kHz
Crossover frequencies	450Hz, 2.1kHz
Recommended amplifier power	50 - 200W
Sensitivity (2.83V/1m)	85dB
Harmonic distortion 2 nd & 3 rd harmonics (90dB, 1m)	<0.5% 40Hz and above <0.2% 200Hz - 2kHz <0.1% 2kHz - 20kHz
Maximum output (Peak sound pressure level at 1m with pink noise)	111dB
Impedance	4 Ω (min. 3.2 Ω)
Weight	18.2 kg (40.1 lbs)
Dimensions with terminals (H x W x D)	440 x 205 x 422 mm (17.3 x 8.1 x 16.6 in.)

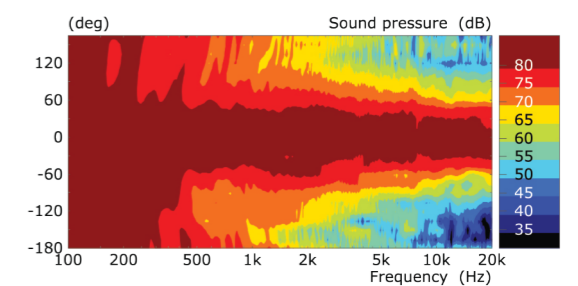
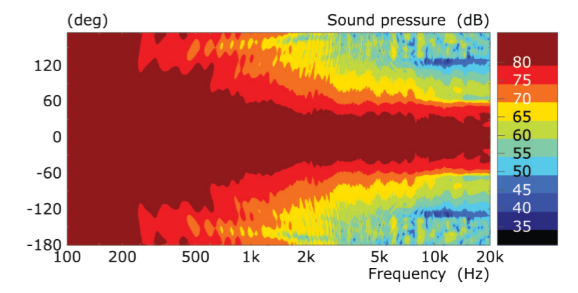
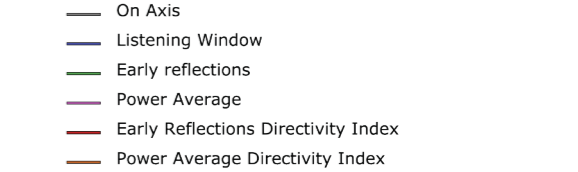
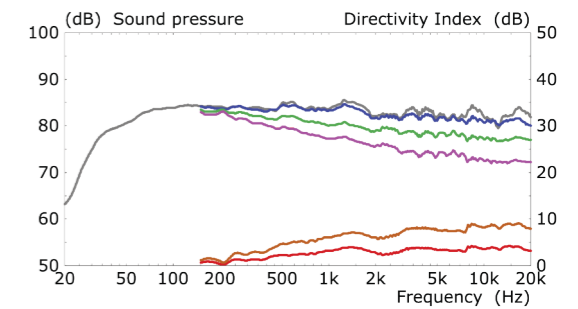

Reference 1 Meta Spinorama (top) and dispersion plots - horizontal (middle) and vertical (bottom)

Reference 4 Meta

Three-way LCR Loudspeaker

The larger of the two LCR models, Reference 4 Meta is an ideal match for Reference 5 Meta or Reference 3 Meta in a high-end home theatre system. They can even be used as stereo pairs when built into custom entertainment furniture.



Technical Specifications

System	Three-way bass reflex
Drive units	Uni-Q Driver Array: HF: 25 mm (1 in.) aluminium dome with MAT MF: 125 mm (5 in.) aluminium cone Bass Drivers: LF: 4 x 165mm (6.5 in.) aluminium cone
Frequency range free-field (-6dB)	Long port: 40Hz - 45kHz Short port: 43Hz - 45kHz
Typical in-room bass response (-6dB)	33Hz
Frequency response (±3dB)	48Hz - 35kHz
Crossover frequencies	450Hz, 2.1kHz
Recommended amplifier power	50 - 400W
Sensitivity (2.83V/1m)	88dB
Harmonic distortion 2 nd & 3 rd harmonics (90dB, 1m)	<0.5% 40Hz and above <0.2% 200Hz - 2kHz <0.1% 2kHz - 20kHz
Maximum output (Peak sound pressure level at 1m with pink noise)	116dB
Impedance	4 Ω (min. 3.2 Ω)
Weight	45.2 kg (99.6 lbs)
Dimensions with terminals (H x W x D)	205 x 1090 x 463 mm (8.1 x 42.9 x 18.2 in.)

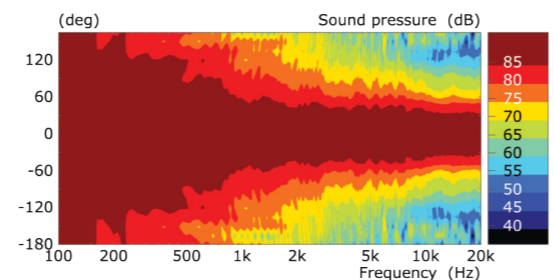
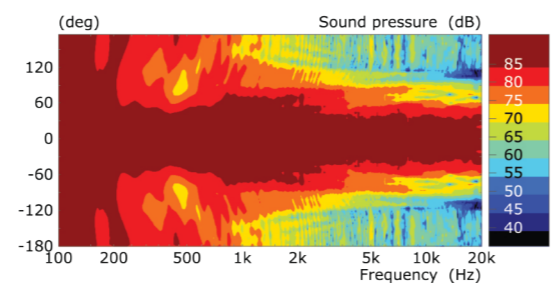
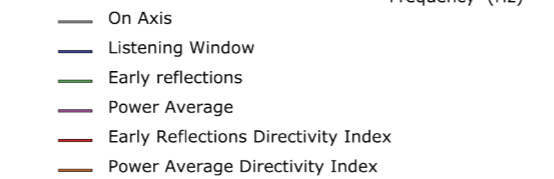
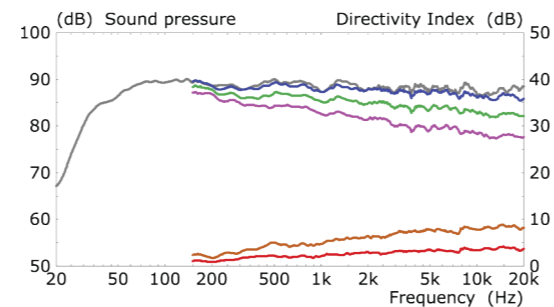

Reference 4 Meta Spinorama (top) and dispersion plots - horizontal (middle) and vertical (bottom)

Reference 2 Meta

Three-way LCR Loudspeaker

Compact, yet extremely capable, especially within dual-purpose spaces such as living rooms. Perfectly at home as a centre/multichannel system speaker, or as left/right stereo pairs.



Technical Specifications

System	Three-way sealed cabinet
Drive units	Uni-Q Driver Array: HF: 25 mm (1 in.) aluminium dome with MAT MF: 125 mm (5 in.) aluminium cone Bass Drivers: LF: 2 x 165mm (6.5 in.) aluminium cone
Frequency range free-field (-6dB)	65Hz - 45kHz
Typical in-room bass response (-6dB)	46Hz
Frequency response (±3dB)	80Hz - 35kHz
Crossover frequencies	450Hz, 2.1kHz
Recommended amplifier power	50 - 300W
Sensitivity (2.83V/1m)	86dB
Harmonic distortion 2 nd & 3 rd harmonics (90dB, 1m)	<0.5% 40Hz and above <0.2% 200Hz - 2kHz <0.1% 2kHz - 20kHz
Maximum output (Peak sound pressure level at 1m with pink noise)	113.5dB
Impedance	4 Ω (min. 3.2 Ω)
Weight	22.8 kg (50.3 lbs)
Dimensions with terminals (H x W x D)	205 x 630 x 335 mm (8.1 x 24.8 x 13.2 in.)

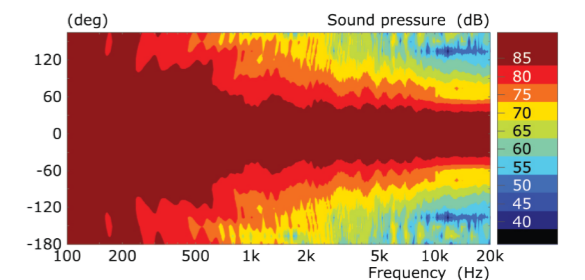
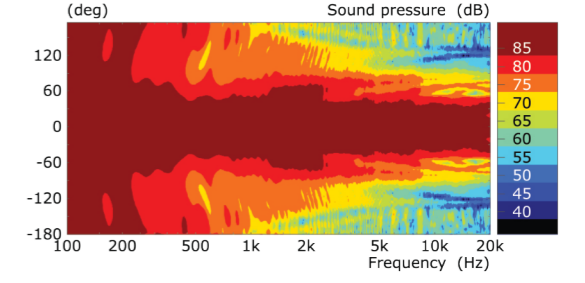
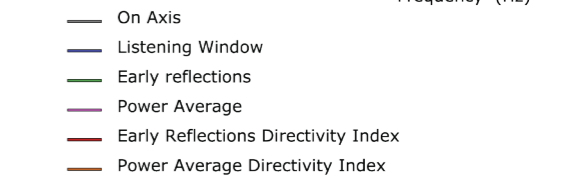
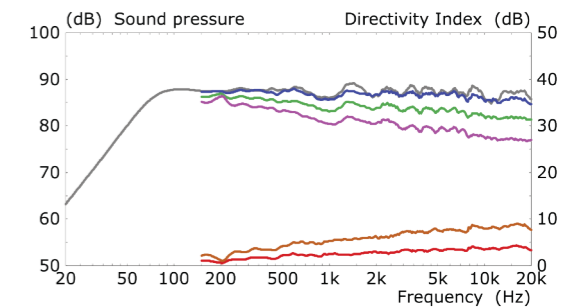

Reference 2 Meta Spinorama (top) and dispersion plots - horizontal (middle) and vertical (bottom)

